



[22MM], 35Bar, SAE J2064 Type E	Mobile Climate Control	<i>FlexCLIK</i> <sup>®</sup> xxxxxxxxxx #16 [22MM], 35Bar, SAE
[16MM], 35Bar, SAE J2064 Type E	Mobile Climate Control	<i>FlexCLIK</i> <sup>®</sup> xxxxxxxxxx #12 [16MM], 35Bar, SAE
[13MM], 35Bar, SAE J2064 Type E	Mobile Climate Control	<i>FlexCLIK</i> <sup>®</sup> xxxxxxxx #10 [13MM], 35Bar, SAE
[10MM], 35Bar, SAE J2064 Type E	Mobile Climate Control	<i>FlexCLIK</i> <sup>®</sup> xxxxxxxxxx #8 [10MM], 35Bar, SAE
Mobile Climate Control	<i>FlexCLIK</i> <sup>®</sup>	58-62192-00 #6 [8MM], 35 Bar, SAE J2064 Type E

**SERVICE PARTS LIST  
AND  
ASSEMBLY INSTRUCTIONS**  
for  
**"FlexCLIK" Hose & Fittings**

**T-352PL**

REV. 11/2012



# TABLE OF CONTENTS

1	INTRODUCTION .....	ii
2	ORDERING INSTRUCTIONS .....	ii
3	GENERAL NOTES .....	ii
	<b>FlexCLIK ASSEMBLY TOOLS .....</b>	<b>1</b>
	FlexCLIK - ASSEMBLY TOOLS .....	2
	<b>FlexCLIK HOSE-FITTING ASSEMBLY INSTRUCTIONS .....</b>	<b>3</b>
	<b>FlexCLIK FITTINGS &amp; Quick-CLICK CROSS-REFERENCE .....</b>	<b>10</b>
	FlexCLIK - CROSS REFERENCE - FlexCLIK & Quick-CLICK .....	10
	FlexCLIK - KITTED PARTS .....	13
	<b>FlexCLIK FITTINGS .....</b>	<b>14</b>
	O-RING PILOT THREAD SIZES .....	14
	FITTING 40-62101 90 Degree Female O-Ring Low Side Port .....	15
	FITTING, 40-62102, TEE .....	15
	FITTING, 40-62103, 90 DEGREE FEMALE O-RING .....	16
	FITTING, 40-62112, HOSE SPLICER, WITH 1/4 SCHRADER .....	16
	FITTING, 40-62127, "Y" .....	17
	FITTING, 40-62128, HOSE SPLICER .....	18
	FITTING, 40-62130, 45 DEGREE MALE O-RING .....	18
	FITTING, 40-62131, 90 DEGREE SPLICER .....	19
	FITTING, 40-62136, GM BLOCK .....	19
	FITTING, 40-64073, 90 DEGREE FEMALE FLARE TO FLX HOSE .....	20
	FITTING, 40-64074 STRAIGHT, FEMALE O-RING .....	20
	FITTING, 40-64075, 90 DEGREE FEMALE O-RING .....	21
	FITTING, 40-64080 90 DEGREE MALE O-RING .....	22
	FITTING, 40-64081 STRAIGHT MALE O-RING .....	22
	FITTING, 40-64082 STRAIGHT, MALE O-RING WITH HIGH SIDE ACCESS .....	23
	FITTING, 40-64084, STRAIGHT .....	23
	FITTING, 40-64089 STRAIGHT, MALE INSERT O-RING .....	24
	FITTING, 40-64092, 90 DEGREE FEMALE O-RING WITH 1/4 SCHRADER .....	24
	FITTING, 40-64094, 90 DEGREE FEMALE O-RING SEAL .....	25
	FITTING, 40-64095, SPLICER, WITH HIGH-SIDE ACCESS .....	25
	FITTING, 40-64106, 45 DEGREE FEMALE O-RING .....	26
	FITTING, 40-64115, SPLICER, WITH LOW-SIDE ACCESS .....	26
	<b>FlexCLIK HOSE - CLAMPS - CAGES &amp; O-RINGS .....</b>	<b>27</b>
	HOSE, FLEXCLIK .....	27
	HOSE CLAMPS / CAGE KITS- FlexCLIK .....	27
	HOSE CLAMPS - FlexCLIK .....	28
	CAGE, FlexCLIK .....	28
	O-RING, FlexCLIK .....	28



## INTRODUCTION

### 1 INTRODUCTION

This Manual identifies service replacement parts for Mobile Climate Control FlexCLIK hose and fittings, along with Assembly Instructions.

MCC FlexCLIK hose is color-coded for ease of identification of hose and fitting assemblies.

BLUE: #12 (16MM) and #16 (22MM) Hose

RED: #10 (13MM) Hose

GREEN: #8 (10MM) Hose

BLACK: #6 (8MM) Hose

### 2 ORDERING INSTRUCTIONS

All orders and inquiries for parts must include: Unit Part Number and description of part as shown on list and quantity required. Parts can be ordered by going to the following website:

[www.mcc-hvac.com](http://www.mcc-hvac.com)

### 3 GENERAL NOTES

To find replacement parts, determine major group in which replacement part is located. Consult table of

contents for the appropriate page for the illustrated breakdown of the replacement part. The following letter designations are used to classify parts throughout this list.

A/R *As Required*

NSA *Not Stock Assembly* - Order components listed under the assembly.

NSI *Not Stock Item*

NSS *Not Sold Separately* - Order next higher assembly or kit.

P-- *Suffix P--* added to part number means part is available in packaged quantity only.

PL *Purchase Locally.*

SST *Stainless Steel* - 300 Series unless otherwise specified.

SV *Suffix SV* added to part number designates service replacement part.

NS *Not Shown* on illustration.



## CAUTION

Special care should be taken when selecting the proper refrigerant hose and fittings. The information contained in this manual is provided as a general guide to assist in making the appropriate product selection. This manual does not address every parameter that must be considered when selecting a product. The user must make the final product selection in consideration of the user's unique requirements.

Additionally, special care must be taken when working with refrigerant systems. Sudden escape of refrigerant gases may result in blindness or severe injury. Mobile Climate Control recommends adherence to the guidelines and general practices as defined in SAE J2211 for the service and containment of HFC-134a, as well as all applicable EPA guidelines and procedures concerning the service of refrigerant systems.



## WARNING

Failure to follow these assembly instructions and/or the use of MCC FlexCLIK hose with fittings supplied by other manufacturers may result in unreliable and unsafe hose assemblies, which may result in sudden or unintended release of refrigerant gases. Personal injury and/or violations of EPA regulations may occur as a consequence.



### SECTION 1

### FlexCLIK ASSEMBLY TOOLS



	SIZE 12	SIZE 10	SIZE 8	SIZE 6
CAGE - 10 Count SIZE 12 IF40105-12C	CAGE - 10 Count SIZE 10 IF40105-10C	CAGE - 10 Count SIZE 8 IF40105-8C	CAGE - 10 Count SIZE 6 IF40105-6C	
CLIPS - 20 Count SIZE 12 IF40104-12C	CLIPS - 20 Count SIZE 10 IF40104-10C	CLIPS - 20 Count SIZE 8 IF40104-8C	CLIPS - 20 Count SIZE 6 IF40104-6C	
<b>HOSE CUTTER WITH BLADE PACKAGE</b> F11356 or (T-135) Cutter F11356-2-1 or (T-135B) Blades				
Correct O-ring size for male and female tube connections:				
	22546-17 (7W74712)	22546-15 (7W74710)	22546-13 (7W74708)	22546-11 (7W74706)

Part Number	Description
07-00507-00	MCC FlexCLIK System Installation Kit



**FlexCLIK - ASSEMBLY TOOLS**



Part Number	Description
07-00508-00	Ratching Connecting Tool for #16 Hose
07-00467-00	Connecting Tool (Pliers)
AC101-708	Hose Cutter Tool
AC101-711	Hose Cutter Replacement Blade
07-00507-00	MCC FlexCLIK System Installation Kit

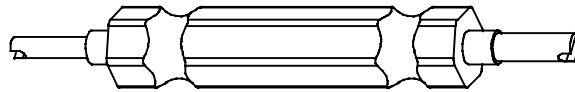

Part Number	Description
Y03-00001-00	Core Access Tool (High & Low Access Fittings)

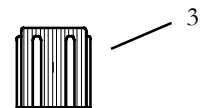
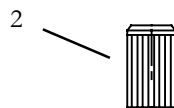
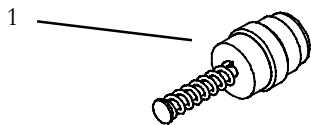

Item	Part Number	Description	Qty
1	Y27-00047-00	Access Core, R-134a Low Side	1
	Y27-00047-01	Access Core, R-134a High Side	1
2	Y27-00048-00	Cap, Access Port, R-134a Low Side	1
3	Y27-00048-01	Cap, Access Port, R-134a High Side	1



## SECTION 2

### FlexCLIK HOSE-FITTING ASSEMBLY INSTRUCTIONS

The FlexCLIK System is designed for assembly with FlexCLIK multi-refrigerant hose. Its engineered connection exceeds SAE J2064 and has been vibration and impulse tested. The benefits of FlexCLIK are virtually endless:

- No Guess Work
- No leaking Crimps
- No power supply needed
- As easy to use as a pair of pliers
- Easy to use in confined areas

FlexCLIK System Components Are Simple To Identify, Order And Use.

#### CHECKLIST

- Pliers (07-00467-00)
- Cutting Tool (AC101-708)
- Refrigerant oil compatible with refrigeration or A/C system
- FlexCLIK refrigerant hose
- FlexCLIK Nipple assembly
- Appropriately sized clips and cage

**NOTE:** The two black O-Rings on the FlexCLIK nipple assemblies are of a specific rubber compound and size. For safety purposes, FlexCLIK specific O-Rings must be used.



FlexCLIK - ASSEMBLY INSTRUCTIONS : Continued

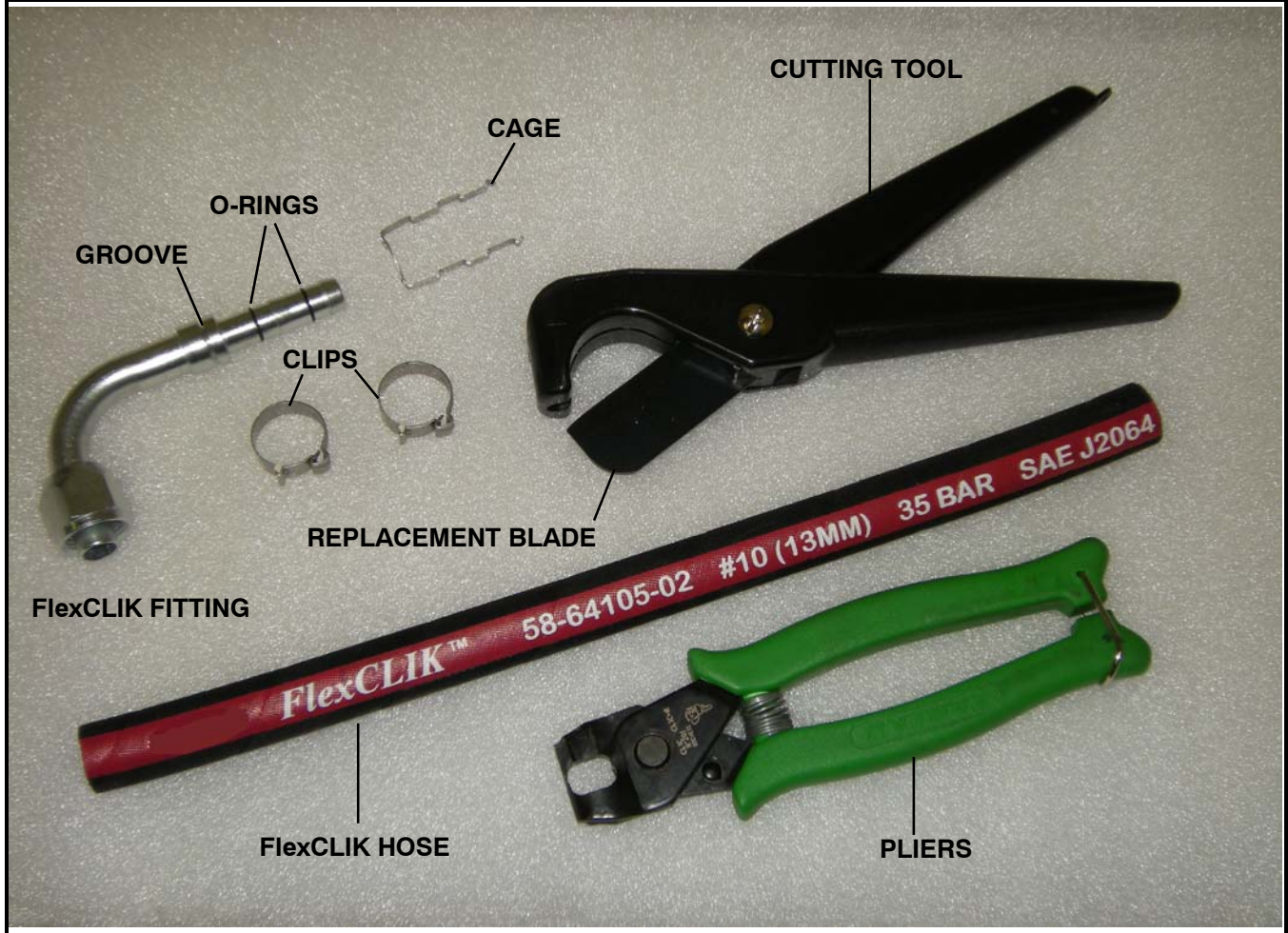



**FlexCLIK - ASSEMBLY INSTRUCTIONS - Continued:**

**Step 1: Cut the Hose**

Cut the hose to proper length with an appropriate cutting tool.

Be sure the cut is made square to the hose length.



**Step 2: Slide on Two Clips**

Install two proper-sized clips onto the cut end of the hose.

Orientation of the clips does not affect the performance of the connection. However, for ease of assembly, both clips should have the same orientation.

**Note:** Failure to slide the clips over the hose at this time will require the clips to be stretched over the hose or fitting later, which may permanently damage the clip.

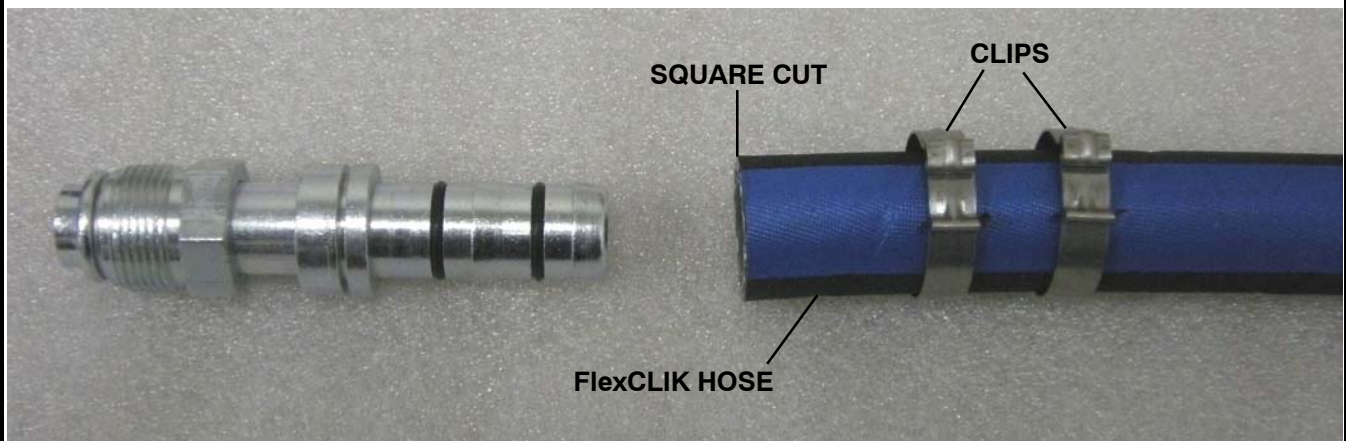

**Step 3: Oil the Nipple**

Lubricate the nipple with a generous amount of mineral oil or the A/C system's compressor lubricating oil. This **MUST** be done to lower the force of nipple insertion.





**FlexCLIK - ASSEMBLY INSTRUCTIONS - Continued:**

**Step 4: Insert the Nipple into the Hose**

To ensure that the nipple is fully inserted, check the gap between the cut end of the hose and the shoulder of the nipple. Care should be taken to avoid kinking or other damage to the hose during nipple insertion.

**NOTE:** Be sure to wipe excess oil from the nipple and hose

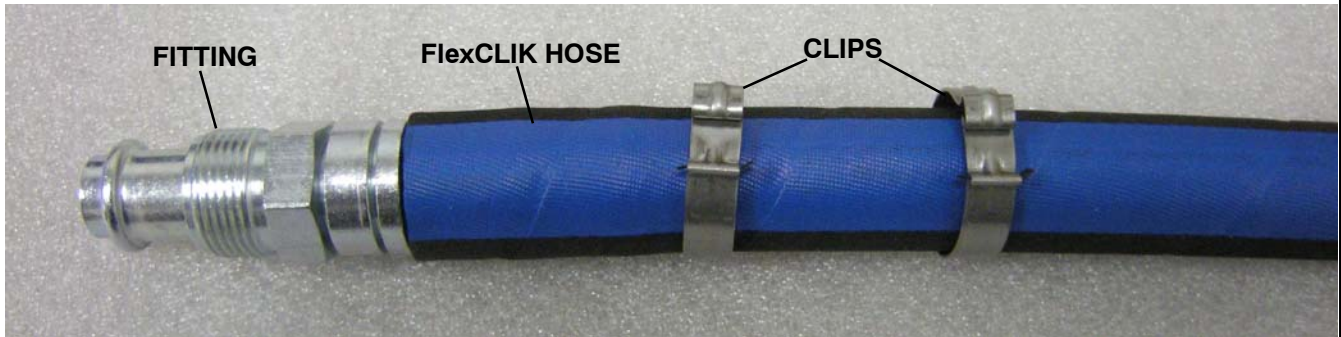

**Step 5: Snap on the Cage**

Snap the cage into the groove on the nipple. The arms should extend over the hose length. When the cage has been correctly installed in the cage groove, the cage will be able to rotate in the groove. This step **MUST** be performed to ensure:

1. The clips will be located over the O-Rings on the nipple.
2. The connection will be compatible with the connection's pressure rating

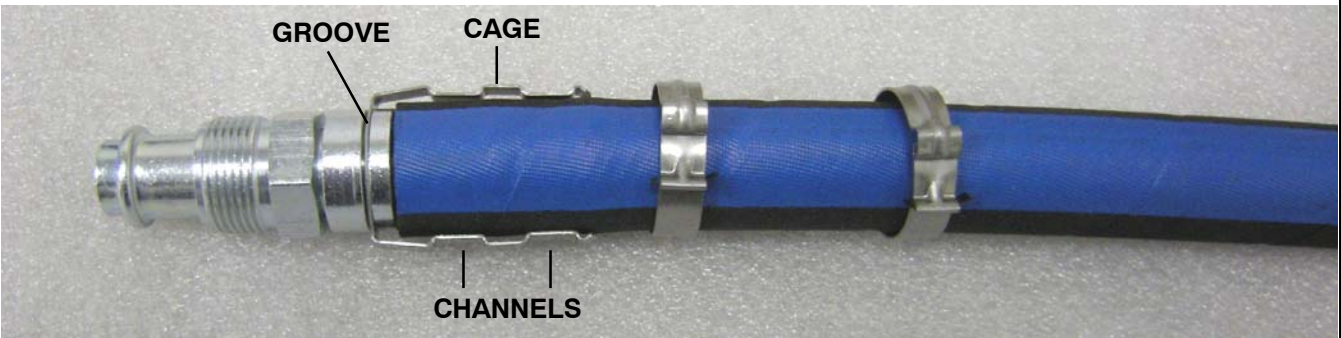

**Step 6: Slide the Clips**

Slide the clips over the cage arms and into the channels on each arm. **SEE BELOW**





**FlexCLIK - ASSEMBLY INSTRUCTIONS - Continued:**

**Step 7: Close the Clips**

Use the FlexCLIK pliers to close the clips. The pliers should be positioned squarely on the clip connection points and should remain square during the closing of the clip. **SEE BELOW**



Nose of the pliers should be firmly seated under the assembly bump and lock latch.

If the pliers are not kept square during closing of the clip, the clasp may have an off-set. Use the pliers to correct the clasp alignment.



**Notice:** FlexCLIK components should not be reused. For recommendations on cleaning and routing hose assemblies, please consult “Mobile Climate Control Installation Procedures Manual T-311.



FlexCLIK - ASSEMBLY INSTRUCTIONS - Continued:

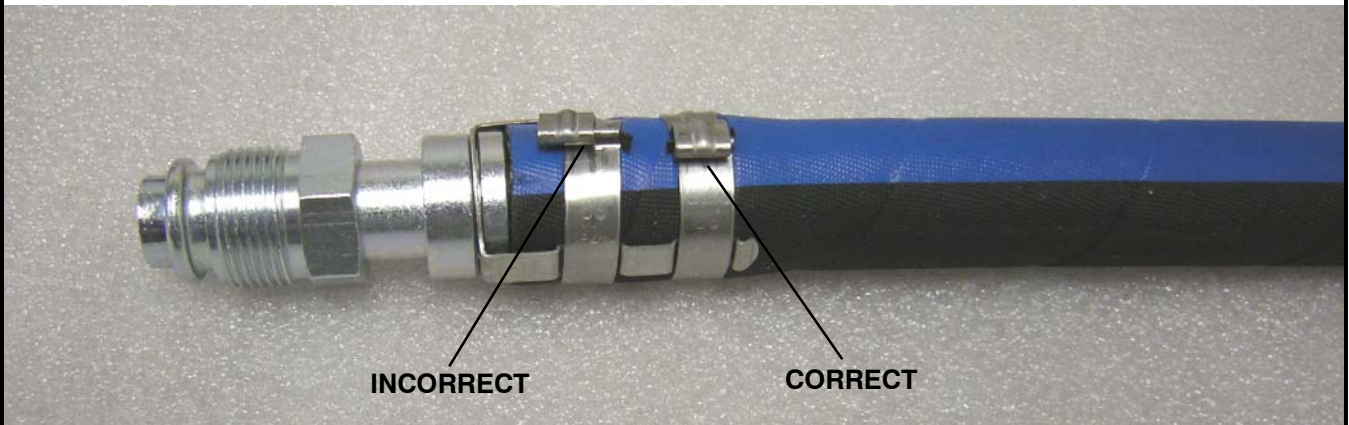



**WARNING**

**FAILURE TO FOLLOW THESE ASSEMBLY INSTRUCTIONS AND/OR THE USE OF MOBILE CLIMATE CONTROL FlexCLIK HOSE WITH FITTINGS SUPPLIED BY OTHER MANUFACTURERS MAY RESULT IN UNRELIABLE AND UNSAFE HOSE ASSEMBLIES, WHICH MAY RESULT IN SUDDEN OR UNINTENDED ESCAPE OF REFRIGERANT GASES. PERSONAL INJURY AND/OR VIOLATIONS OF EPA REGULATIONS MAY OCCUR AS A CONSEQUENCE.**



**CAUTION**

**MOBILE CLIMATE CONTROL RECOMMENDS ADHERENCE TO ALL GUIDELINES, INCLUDING EPA GUIDELINES, CONCERNING THE SERVICE OF AIR CONDITIONING SYSTEMS.**



**SECTION 3**

**FlexCLIK FITTINGS & Quick-CLICK CROSS-REFERENCE**

<b>FlexCLIK - CROSS REFERENCE - FlexCLIK &amp; Quick-CLICK</b>		
<b>FlexCLIK KITTED PART NUMBER</b>	<b>FITTING DESCRIPTION</b>	<b>Quick-CLICK</b>
40-62101-50	90°, #10 FOR X #10 Hose, FlexCLIK	40-62023-01
40-62101-51	90°, #12 FOR X #12 Hose, FlexCLIK	N/A
40-62101-55	90°, #10 FOR X #12 Hose, FlexCLIK	40-62023-00
40-62102-50	TEE, #8 X #8 X #8 Hose, FlexCLIK	40-62012-00
40-62102-51	TEE, #10 X #10 X #10 Hose, FlexCLIK	40-62012-02
40-62102-52	TEE, #12 X #12 X #12 Hose, FlexCLIK	40-62012-01
40-62103-50	90°, #8 FOR X #10 Hose, W/HSA, FlexCLIK	40-62022-00
40-62103-51	90°, #8 FOR X #8 Hose, W/HSA, FlexCLIK	40-62022-01
40-62112-50	Splicer, #6 Hose, FLX, With 1/4 Inch Schrader	40-60081-02
40-62112-51	Splicer, #8 Hose, FLX, With 1/4 Inch Schrader	40-60081-03
40-62112-52	Splicer, #10 Hose, FLX, With 1/4 Inch Schrader	40-60081-04
40-62112-53	Splicer, #12 Hose, FLX, With 1/4 Inch Schrader	40-60081-05
40-62112-54	Splicer, #16 Hose, FLX, With 1/4 Inch Schrader	N/A
40-62128-53	Splicer, #8 Hose, FlexCLIK	40-60086-03
40-62128-54	Splicer, #10 Hose, FlexCLIK	40-60086-04
40-62128-55	Splicer, #12 Hose, FlexCLIK	40-60086-05
40-62128-56	Splicer, #16 Hose, FlexCLIK	N/A
40-62130-50	45°, #6 MOR X #8 Hose, FlexCLIK	40-60084-06
40-62130-51	45°, #10 MOR X #12 Hose, FlexCLIK	40-60084-05
40-62131-50	90°, Splicer, #8 Hose, FlexCLIK	40-60137-03
40-62131-51	90°, Splicer, #10 Hose, FlexCLIK	40-60137-04
40-62131-52	90°, Splicer, #12 Hose, FlexCLIK	40-60137-05
40-62136-50	90°, GM Block X #10 Hose, FlexCLIK	40-62088-00
40-62136-51	90°, GM Block X #12 Hose, FlexCLIK	40-62089-00
40-64073-50	90°, #6 FFL X #6 Hose, FlexCLIK	40-60079-02
40-64073-51	90°, #6 FFL X #8 Hose, FlexCLIK	N/A
40-64073-52	90°, #8 FFL X #8 Hose, FlexCLIK	40-60079-03
40-64073-53	90°, #10 FFL X #10 Hose, FlexCLIK	40-60079-04
40-64073-54	90°, #10 FFL X #12 Hose, FlexCLIK	40-60079-07
40-64073-55	90°, #12 FFL X #12 Hose, FlexCLIK	40-60079-05
40-64074-50	#6 Straight, FOR X #6 Hose, FlexCLIK	40-60060-02
40-64074-51	#6 Straight, FOR X #8 Hose, FlexCLIK	40-60060-08
40-64074-52	#8 Straight, FOR X #8 Hose, FlexCLIK	40-60060-03
40-64074-53	#8 Straight, FOR X #10 Hose, FlexCLIK	40-60060-06
40-64074-54	#10 Straight, FOR X #10 Hose, FlexCLIK	40-60060-04
40-64074-55	#10 Straight, FOR X #12 Hose, FlexCLIK	40-60060-07
40-64074-56	#12 Straight, FOR X #12 Hose, FlexCLIK	40-60060-05
40-64074-57	#10 Straight, FOR X #8 Hose, FlexCLIK	N/A
40-64074-58	#12 Straight, FOR X #10 Hose, FlexCLIK	N/A
40-64074-59	#10 Straight, FOR X #16 Hose, FlexCLIK	N/A
40-64074-60	#12 Straight, FOR X #16 Hose, FlexCLIK	N/A



<b>FlexCLIK - CROSS REFERENCE - FlexCLIK &amp; Quick-CLICK - Continued:</b>		
<b>FlexCLIK KITTED PART NUMBER</b>	<b>FITTING DESCRIPTION</b>	<b>Quick-CLICK</b>
40-64075-50	90°, #6 FOR X #6 Hose, FlexCLIK	40-60061-02
40-64075-51	90°, #6 FOR X #8 Hose, FlexCLIK	40-60061-08
40-64075-52	90°, #8 FOR X #8 Hose, FlexCLIK	40-60061-03
40-64075-53	90°, #8 FOR X #10 Hose, FlexCLIK	40-60061-06
40-64075-54	90°, #10 FOR X #10 Hose, FlexCLIK	40-60061-04
40-64075-55	90°, #10 FOR X #12 Hose, FlexCLIK	40-60061-07
40-64075-56	90°, #12 FOR X #12 Hose, FlexCLIK	40-60061-05
40-64075-57	90°, #8 FOR X #6 Hose, FlexCLIK	N/A
40-64075-58	90°, #12 FOR X #10 Hose, FlexCLIK	N/A
40-64075-59	90°, #12 FOR X #16 Hose, FlexCLIK	N/A
40-64080-50	90°, #10 MOR X #12 Hose, FlexCLIK	40-60083-07
40-64080-51	90°, #6 MOR X #8 Hose, FlexCLIK	40-60083-08
40-64080-52	90°, #12 MOR X #12 Hose, FlexCLIK	N/A
40-64080-53	90°, #8 MOR X #10 Hose, FlexCLIK	N/A
40-64080-56	90°, #6 MOR X #6 Hose, FlexCLIK	40-60083-02
40-64080-57	90°, #8 MOR X #8 Hose, FlexCLIK	40-60083-03
40-64080-58	90°, #10 MOR X #12 Hose, FlexCLIK	40-60083-04
40-64080-59	90°, #12 MOR X #10 Hose, FlexCLIK	N/A
40-64081-50	Straight, #6 MOR X #8 Hose, FlexCLIK	40-60051-08
40-64081-51	Straight, #10 MOR X #12 Hose, FlexCLIK	40-60051-07
40-64081-52	Straight, #8 MOR X #8 Hose, FlexCLIK	40-60051-03
40-64081-53	Straight, #6 MOR X #6 Hose, FlexCLIK	40-60051-02
40-64081-54	Straight, #10 MOR X #10 Hose, FlexCLIK	40-60051-04
40-64081-55	Straight, #12 MOR X #12 Hose, FlexCLIK	N/A
40-64081-56	Straight, #10 MOR X #16 Hose, FlexCLIK	N/A
40-64081-57	Straight, #12 MOR X #16 Hose, FlexCLIK	N/A
40-64082-50	Straight, #10 MOR X #10 Hose, HS, FlexCLIK	N/A
40-64082-51	Straight, #6 MOR X #6 Hose, HS, FlexCLIK	N/A
40-64082-52	Straight, #8 MOR X #8 Hose, HS, FlexCLIK	N/A
40-64084-50	Straight, #8 FFL X #8 Hose, FlexCLIK	40-60078-03
40-64084-51	Straight, #6 FFL X #8 Hose, FlexCLIK	N/A
40-64084-52	Straight, #12 FFL X #12 Hose, FlexCLIK	40-60078-05
40-64084-53	Straight, #8 FFL X #10 Hose, FlexCLIK	40-60078-06
40-64084-54	Straight, #10 FF X #10 Hose, FlexCLIK	40-60078-04
40-64084-55	Straight, #6 FFL X #6 Hose, FlexCLIK	40-60078-02
40-64084-56	Straight, #10 FFL X #12 Hose, FlexCLIK	40-60078-07
40-64089-50	Straight, #6 MIO X #6 Hose, FlexCLIK	N/A
40-64089-51	Straight, #8 MIO X #8 Hose, FlexCLIK	N/A
40-64089-52	Straight, #10 MIO X #10 Hose, FlexCLIK	N/A
40-64089-53	Straight, #10 MIO X #12 Hose, FlexCLIK	N/A
40-64089-54	Straight, #12 MIO X #12 Hose, FlexCLIK	N/A
40-64092-50	90°, #10 FOR X #10 Hose W/1/4 Schrader, FLK	N/A
40-64092-51	90°, #12 FOR X #12 Hose W/1/4 Schrader, FLK	N/A
40-64094-50	90°, #10 F.Swivel, ORS X #10 Hose, FlexCLIK	40-60048-04



FlexCLIK - CROSS REFERENCE - FlexCLIK & Quick-CLICK - Continued:		
FlexCLIK KITTED PART NUMBER	FITTING DESCRIPTION	Quick-CLICK
40-64094-51	90°, #6 F.Swivel, ORS X #6 Hose, FlexCLIK	40-60048-02
40-64094-52	90°, #8 F.Swivel, ORS X #8 Hose, FlexCLIK	40-60048-03
40-64094-53	90°, #12 F.Swivel, ORS X #12 Hose, FlexCLIK	40-60048-05
40-64094-54	90°, #4 F.Swivel, ORS X #6 Hose, FlexCLIK	40-60048-01
40-64094-55	90°, #10 F.Swivel, ORS X #12 Hose, FlexCLIK	40-60048-07
40-64094-56	90°, #8 F.Swivel, ORS X #6 Hose, FlexCLIK	40-60048-10
40-64094-57	90°, #10 F.Swivel, ORS X #16 Hose, FlexCLIK	N/A
40-64094-58	90°, #10 F.Swivel, ORS X #12 Hose, FlexCLIK	N/A
40-64095-50	Splicer, #10 Hose, FlexCLIK, W/High Side Access	40-60059-04
40-64095-51	Splicer, #6 Hose, FlexCLIK, W/High Side Access	40-60059-02
40-64095-52	Splicer, #8 Hose, FlexCLIK, W/High Side Access	40-60059-03
40-64106-50	45°, #12 FOR X #12 Hose, FlexCLIK	40-60050-05
40-64106-51	45°, #6 FOR X #6 Hose, FlexCLIK	40-60050-02
40-64106-52	45°, #6 FOR X #8 Hose, FlexCLIK	40-60050-08
40-64106-53	45°, #8 FOR X #8 Hose, FlexCLIK	40-60050-03
40-64106-54	45°, #8 FOR X #10 Hose, FlexCLIK	40-60050-06
40-64106-55	45°, #10 FOR X #10 Hose, FlexCLIK	40-60050-04
40-64106-56	45°, #10 FOR X #12 Hose, FlexCLIK	40-60050-07
40-64106-57	45°, #12 FOR X #16 Hose, FlexCLIK	N/A
40-64106-58	45°, #10 FOR X #16 Hose, FlexCLIK	N/A
40-64115-50	Splicer, #10 Hose, FlexCLIK, W/Low Side Access	40-60058-04
40-64115-51	Splicer, #12 Hose, FlexCLIK, W/Low Side Access	40-60058-05
40-64115-52	Splicer, #16 Hose, FlexCLIK, W/Low Side Access	40-64115-52

**FlexCLIK FITTING PART NUMBER - KITTED**

**Fitting Assemblies are sold as a Kit.** The FlexCLIK Fitting Kit will include: (1) fitting, (2) FlexCLIK Hose Clamps (Clips) & (1) Cage, all in an MCC pre-printed plastic bag with Bar Code, hose fitting color strip, date code and fitting description (See example below).



FlexCLIK - KITTED PARTS

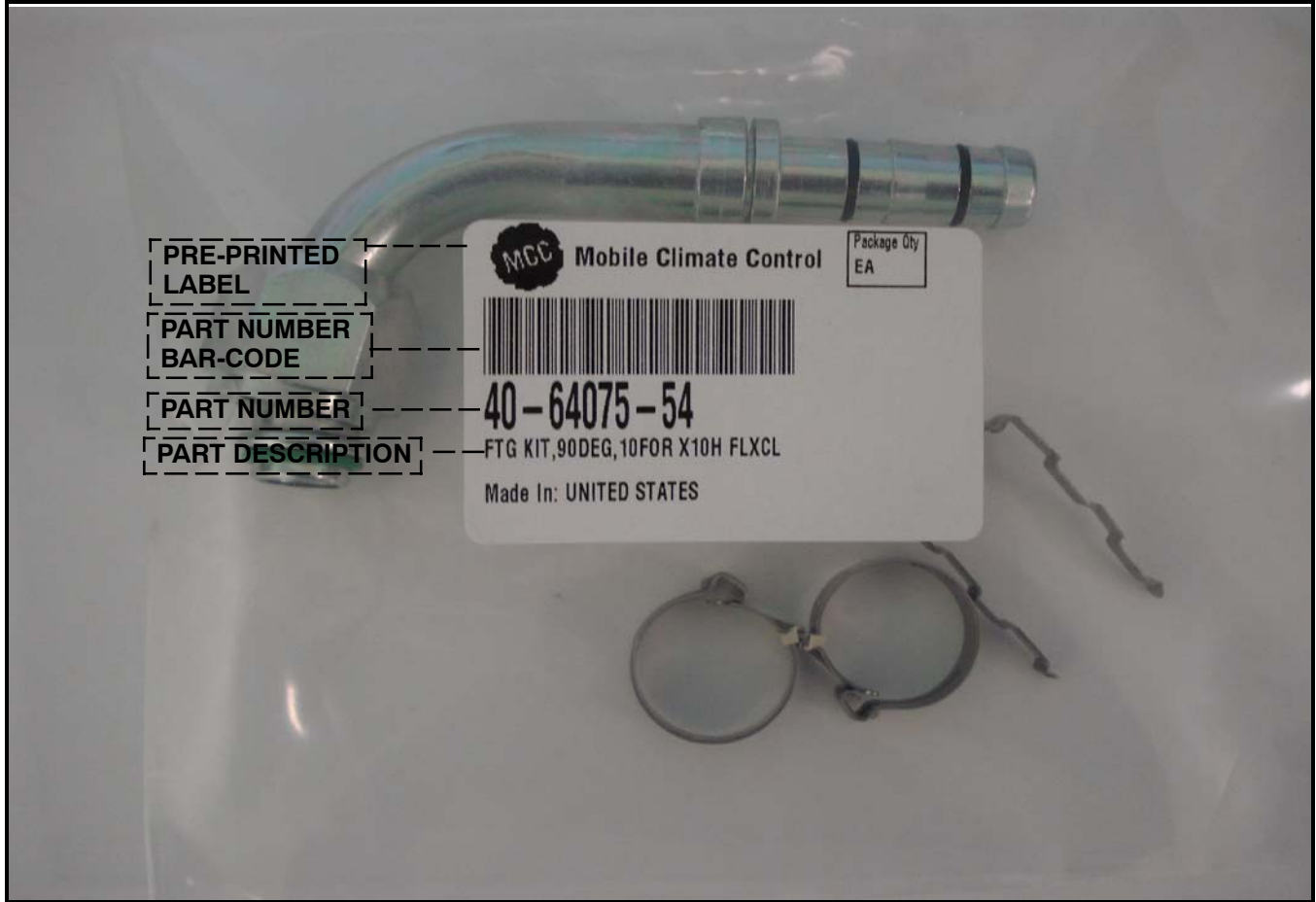

PRE-PRINTED LABEL

PART NUMBER BAR-CODE

PART NUMBER

PART DESCRIPTION

MCC Mobile Climate Control  
Package Qty  
EA  
40-64075-54  
FTG KIT, 90DEG, 10FOR X10H FLXCL  
Made In: UNITED STATES



## SECTION 4

### FlexCLIK FITTINGS

#### O-RING PILOT THREAD SIZES

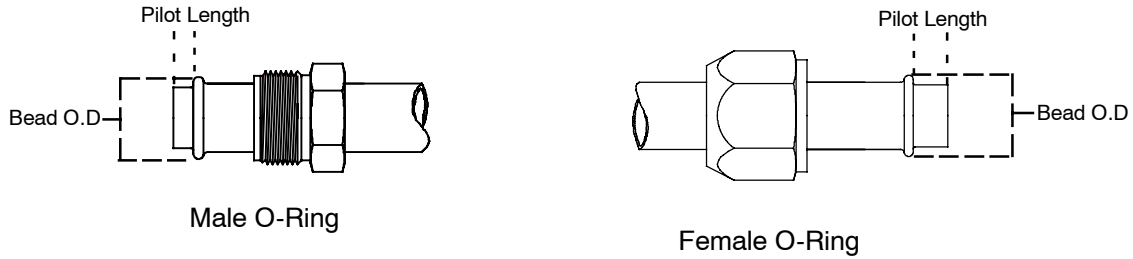

Male Thread O.D (Inch)					Female Thread I.D. (Inch)		
Inch Size	Dash Size	Thread	Fraction	Decimal	Thread	Fraction	Decimal
3/8	06	5/8-18	5/8	.62	5/8-18	9/16	.57
1/2	08	3/4-18	3/4	.75	3/4-16	11/16	.69
5/8	10	7/8-18	7/8	.87	7/8-14	13/16	.81
3/4	12	1-1/16-16	1-1/16	1.06	11/16-14	1	.99

Long Pilot				Short Pilot	
Inch Size	Nom. Tube Size	Bead O.D (Inch)	Pilot Length	Bead O.D. (Inch)	Pilot Length
3/8	06	.52	.28	.52	.19
1/2	08	.64	.39	.64	.19
5/8	10	.77	.39	.77	.19
3/4	12	.91	.39	.91	.19

This connection is common to air conditioning systems, both in vehicle and commercial applications. Both the male and female halves of the connections have a pilot, either long or short. The seal takes place by compressing an O-Ring adjacent to the bead of the tube. The threads hold the connection together mechanically.



**FITING 40-62101 90 Degree Female O-Ring Low Side Port**

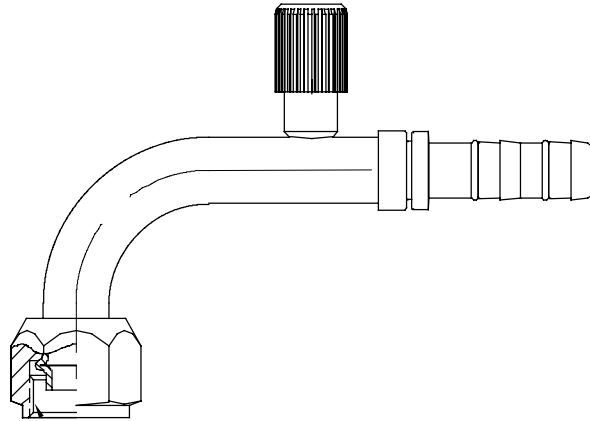

Kit Part Number	Description
40-62101-50	Fitting, 90°, #10 FOR (Short Pilot) W/R134a Low Side Port X #10 Hose
40-62101-51	Fitting, 90°, #12 FOR (Short Pilot) W/R134a Low Side Port X #12 Hose
40-62101-55	Fitting, 90°, #10 FOR (Short Pilot) W/R134a Low Side Port X #12 Hose

**FITTING, 40-62102, TEE**

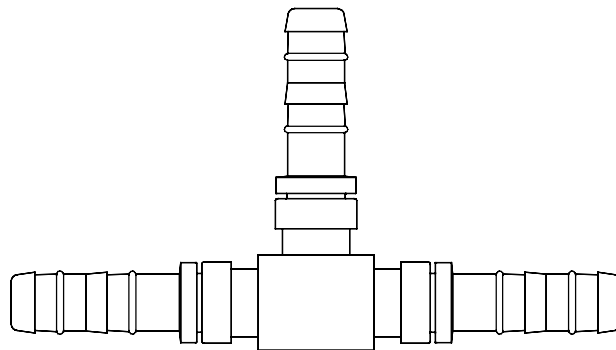

Kit Part Number	Description
40-62102-50	Fitting, TEE, #8 X #8 X #8 Hose, FlexCLIK
40-62102-51	Fitting, TEE, #10 X #10 X #10 Hose, FlexCLIK
40-62102-52	Fitting, TEE, #12 X #12 X #12 Hose, FlexCLIK



**FITTING, 40-62103, 90 DEGREE FEMALE O-RING**

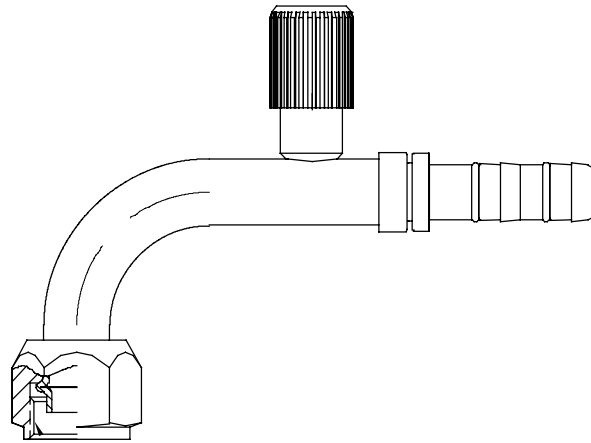

Kit Part Number	Description
40-62103-50	Fitting, 90°, #8 FOR With R134a High Side Port X #10 Hose
40-62103-51	Fitting, 90°, #8 FOR With R134a High Side Port X #8 Hose,

**FITTING, 40-62112, HOSE SPLICER, WITH 1/4 SCHRADER**

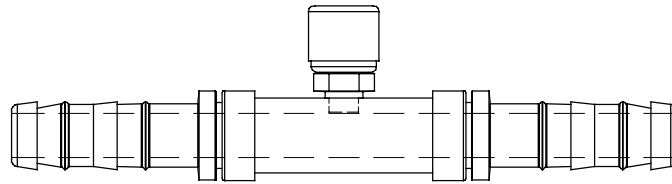

Kit Part Number	Description
40-62112-50	Fitting, Splicer, #6 Hose, FlexCLIK Hose, With 1/4 Inch Schrader
40-62112-51	Fitting, Splicer, #8 Hose, FlexCLIK Hose, With 1/4 Inch Schrader
40-62112-52	Fitting, Splicer, #10 Hose, FlexCLIK Hose, With 1/4 Inch Schrader
40-62112-53	Fitting, Splicer, #12 Hose, FlexCLIK Hose, With 1/4 Inch Schrader
40-62112-54	Fitting, Splicer, #16 Hose, FlexCLIK Hose, With 1/4 Inch Schrader



**FITTING, 40-62127, "Y"**

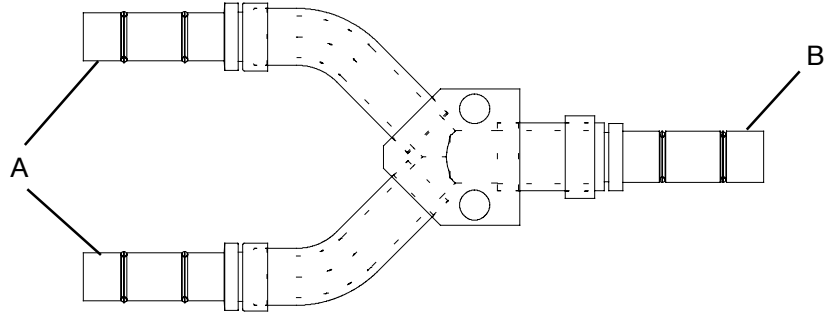

Kit Part Number	Description
40-62127-50	Fitting, "Y", 8(A) x 8(A) to 8(B), FlexCLIK Hose
40-62127-51	Fitting, "Y", 10(A) x 10(A) to 10(B), FlexCLIK Hose
40-62127-52	Fitting, "Y", 10(A) x 10(A) to 12(B), FlexCLIK Hose
40-62127-53	Fitting, "Y", 12(A) x 12(A) to 12(B), FlexCLIK Hose
40-62127-54	Fitting, "Y", 12(A) x 12(A) to 16(B), FlexCLIK Hose



**FITTING, 40-62128, HOSE SPLICER**

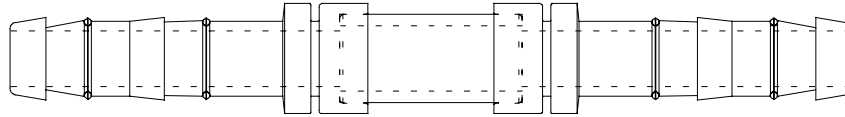

Kit Part Number	Description
40-62128-52	Fitting, Splicer, #6 Hose, FlexCLIK Hose
40-62128-53	Fitting, Splicer, #8 Hose, FlexCLIK Hose
40-62128-54	Fitting, Splicer, #10 Hose, FlexCLIK Hose
40-62128-55	Fitting, Splicer, #12 Hose, FlexCLIK Hose
40-62128-56	Fitting, Splicer, #16 Hose, FlexCLIK Hose

**FITTING, 40-62130, 45 DEGREE MALE O-RING**

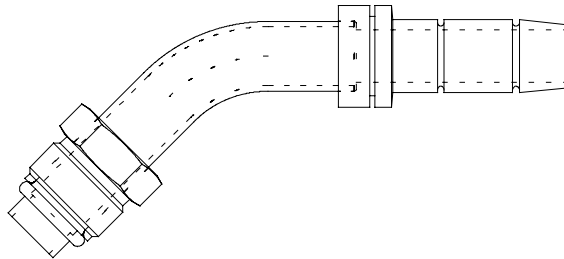

Kit Part Number	Description
40-62130-50	Fitting, 45°, #6 MOR X #8 Hose, FlexCLIK
40-62130-51	Fitting, 45°, #10 MOR X #12 Hose, FlexCLIK



**FITTING, 40-62131, 90 DEGREE SPLICER**

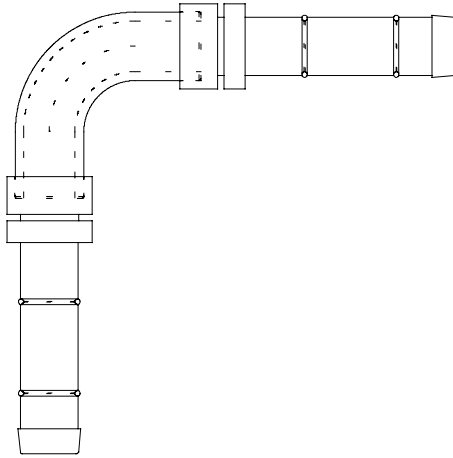

Kit Part Number	Description
40-62131-50	Fitting, 90°, Splicer, #8 Hose, FlexCLIK
40-62131-51	Fitting, 90°, Splicer, #10 Hose, FlexCLIK
40-62131-52	Fitting, 90°, Splicer, #12 Hose, FlexCLIK

**FITTING, 40-62136, GM BLOCK**

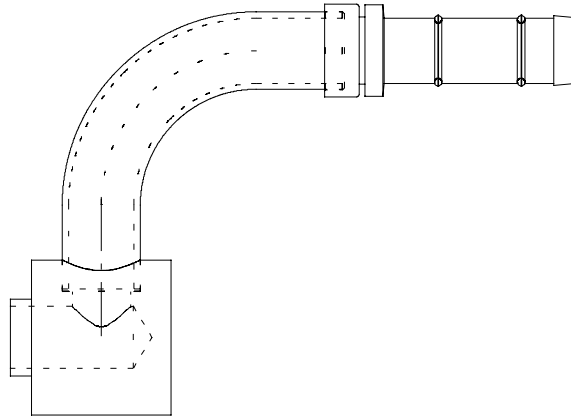

Kit Part Number	Description
40-62136-50	Fitting, 90°, GM Block Style X #10 Hose, FlexCLIK
40-62136-51	Fitting, 90°, GM Block Style X #12 Hose, FlexCLIK



**FITTING, 40-64073, 90 DEGREE FEMALE FLARE TO FLX HOSE**

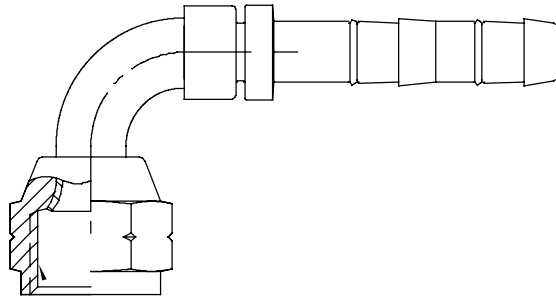

Kit Part Number	Description
40-64073-50	Fitting, 90°, #6 Female SAE 45° Flare X #6 Hose, FlexCLIK
40-64073-51	Fitting, 90°, #6 Female SAE 45° Flare X #8 Hose, FlexCLIK
40-64073-52	Fitting, 90°, #8 Female SAE 45° Flare X #8 Hose, FlexCLIK
40-64073-53	Fitting, 90°, #10 Female SAE 45° Flare X #10 Hose, FlexCLIK
40-64073-54	Fitting, 90°, #10 Female SAE 45° Flare X #12 Hose, FlexCLIK
40-64073-55	Fitting, 90°, #12 Female SAE 45° Flare X #12 Hose, FlexCLIK

**FITTING, 40-64074 STRAIGHT, FEMALE O-RING**

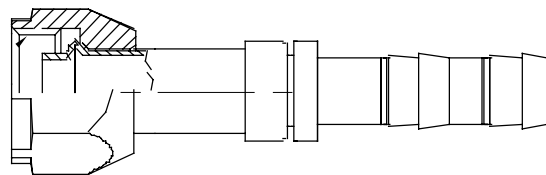

Kit Part Number	Description
40-64074-50	Fitting, #6 Straight, FOR (Short Pilot) X #6 Hose, FlexCLIK
40-64074-51	Fitting, #6 Straight, FOR (Short Pilot) X #8 Hose, FlexCLIK
40-64074-52	Fitting, #8 Straight, FOR (Short Pilot) X #8 Hose, FlexCLIK
40-64074-53	Fitting, #8 Straight, FOR (Short Pilot) X #10 Hose, FlexCLIK
40-64074-54	Fitting, #10 Straight, FOR (Short Pilot) X #10 Hose, FlexCLIK
40-64074-55	Fitting, #10 Straight, FOR (Short Pilot) X #12 Hose, FlexCLIK
40-64074-56	Fitting, #12 Straight, FOR (Short Pilot) X #12 Hose, FlexCLIK
40-64074-57	Fitting, #10 Straight, FOR (Short Pilot) X #8 Hose, FlexCLIK
40-64074-58	Fitting, #12 Straight, FOR (Short Pilot) X #10 Hose, FlexCLIK
40-64074-59	Fitting, #10 Straight, FOR (Short Pilot) X #16 Hose, FlexCLIK
40-64074-60	Fitting, #12 Straight, FOR (Short Pilot) X #16 Hose, FlexCLIK



**FITTING, 40-64075, 90 DEGREE FEMALE O-RING**

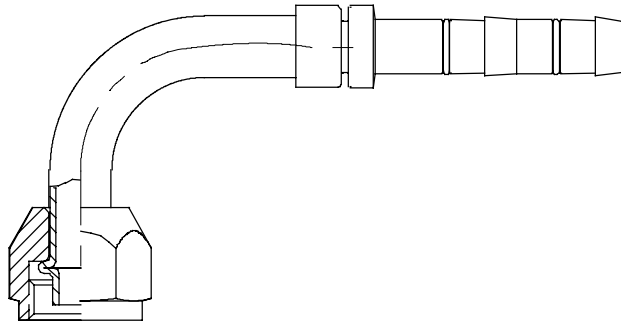

Kit Part Number	Description
40-64075-50	Fitting, 90°, #6 FOR (Short Pilot) X #6 Hose, FlexCLIK
40-64075-51	Fitting, 90°, #6 FOR (Short Pilot) X #8 Hose, FlexCLIK
40-64075-52	Fitting, 90°, #8 FOR (Short Pilot) X #8 Hose, FlexCLIK
40-64075-53	Fitting, 90°, #8 FOR (Short Pilot) X #10 Hose, FlexCLIK
40-64075-54	Fitting, 90°, #10 FOR (Short Pilot) X #10 Hose, FlexCLIK
40-64075-55	Fitting, 90°, #10 FOR (Short Pilot) X #12 Hose, FlexCLIK
40-64075-56	Fitting, 90°, #12 FOR (Short Pilot) X #12 Hose, FlexCLIK
40-64075-57	Fitting, 90°, #8 FOR (Short Pilot) X #6 Hose, FlexCLIK
40-64075-58	Fitting, 90°, #12 FOR (Short Pilot) X #10 Hose, FlexCLIK
40-64075-59	Fitting, 90°, #12 FOR (Short Pilot) X #16 Hose, FlexCLIK





**FITTING, 40-64080 90 DEGREE MALE O-RING**

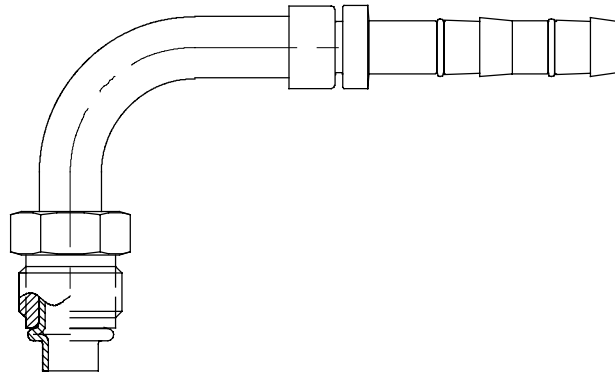

<b>Kit Part Number</b>	<b>Description</b>
40-64080-50	Fitting, 90°, #10 MOR (Short Pilot) X #12 Hose, FlexCLIK
40-64080-51	Fitting, 90°, #6 MOR (Short Pilot) X #8 Hose, FlexCLIK
40-64080-52	Fitting, 90°, #12 MOR (Short Pilot) X #12 Hose, FlexCLIK
40-64080-53	Fitting, 90°, #8 MOR (Short Pilot) X #10 Hose, FlexCLIK
40-64080-56	Fitting, 90°, #6 MOR (Short Pilot) X #6 Hose, FlexCLIK
40-64080-57	Fitting, 90°, #8 MOR (Short Pilot) X #8 Hose, FlexCLIK
40-64080-58	Fitting, 90°, #10 MOR (Short Pilot) X #10 Hose, FlexCLIK
40-64080-59	Fitting, 90°, #12 MOR (Short Pilot) X #10 Hose, FlexCLIK

**FITTING, 40-64081 STRAIGHT MALE O-RING**

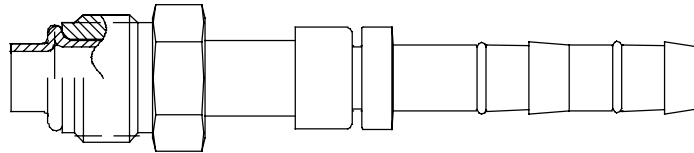

<b>Kit Part Number</b>	<b>Description</b>
40-64081-50	Fitting, Straight, #6 MOR (Short Pilot) X #8 Hose, FlexCLIK
40-64081-51	Fitting, Straight, #10 MOR (Short Pilot) X #12 Hose, FlexCLIK
40-64081-52	Fitting, Straight, #8 MOR (Short Pilot) X #8 Hose, FlexCLIK
40-64081-53	Fitting, Straight, #6 MOR (Short Pilot) X #6 Hose, FlexCLIK
40-64081-54	Fitting, Straight, #10 MOR (Short Pilot) X #10 Hose, FlexCLIK
40-64081-55	Fitting, Straight, #12 MOR (Short Pilot) X #12 Hose, FlexCLIK
40-64081-56	Fitting, Straight, #10 MOR (Short Pilot) X #16 Hose, FlexCLIK
40-64081-57	Fitting, Straight, #12 MOR (Short Pilot) X #16 Hose, FlexCLIK



**FITTING, 40-64082 STRAIGHT, MALE O-RING WITH HIGH SIDE ACCESS**

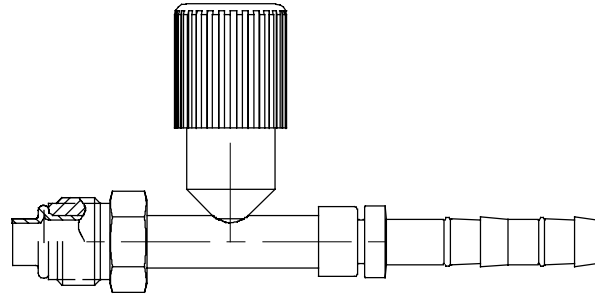

<b>Kit Part Number</b>	<b>Description</b>
40-64082-50	Fitting, Straight, #10 MOR (Short Pilot) X #10 Hose, HS, FlexCLIK
40-64082-51	Fitting, Straight, #6 MOR (Short Pilot) X #6 Hose, HS, FlexCLIK
40-64082-52	Fitting, Straight, #8 MOR (Short Pilot) X #8 Hose, HS, FlexCLIK

**FITTING, 40-64084, STRAIGHT**

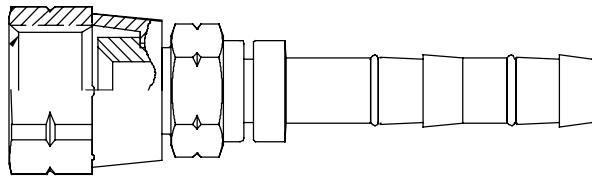

<b>Kit Part Number</b>	<b>Description</b>
40-64084-50	Fitting, Straight, #8 Female SAE 45° Flare X #8 Hose, FlexCLIK
40-64084-51	Fitting, Straight, #6 Female SAE 45° Flare X #8 Hose, FlexCLIK
40-64084-52	Fitting, Straight, #12 Female SAE 45° Flare X #12 Hose, FlexCLIK
40-64084-53	Fitting, Straight, #8 Female SAE 45° Flare X #10 Hose, FlexCLIK
40-64084-54	Fitting, Straight, #10 Female SAE 45° Flare X #10 Hose, FlexCLIK
40-64084-55	Fitting, Straight, #6 Female SAE 45° Flare X #6 Hose, FlexCLIK
40-64084-56	Fitting, Straight, #10 Female SAE 45° Flare X #12 Hose, FlexCLIK



**FITTING, 40-64089 STRAIGHT, MALE INSERT O-RING**

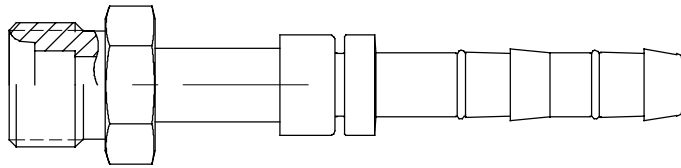

Kit Part Number	Description
40-64089-50	Fitting, Straight, #6 Male Insert O-Ring X #6 Hose, FlexCLIK
40-64089-51	Fitting, Straight, #8 Male Insert O-Ring X #8 Hose, FlexCLIK
40-64089-52	Fitting, Straight, #10 Male Insert O-Ring X #10 Hose, FlexCLIK
40-64089-53	Fitting, Straight, #10 Male Insert O-Ring X #12 Hose, FlexCLIK
40-64089-54	Fitting, Straight, #12 Male Insert O-Ring X #12 Hose, FlexCLIK

**FITTING, 40-64092, 90 DEGREE FEMALE O-RING WITH 1/4 SCHRADER**

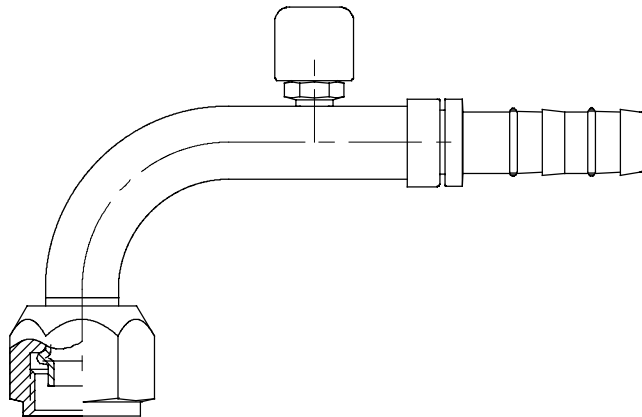

Kit Part Number	Description
40-64092-50	Ftg., 90°, #10 FOR (Short Pilot) X #10 Hose W/1/4" SAE Schrader
40-64092-51	Ftg., 90°, #12 FOR (Short Pilot) X #12 Hose W/1/4" SAE Schrader



**FITTING, 40-64094, 90 DEGREE FEMALE O-RING SEAL**

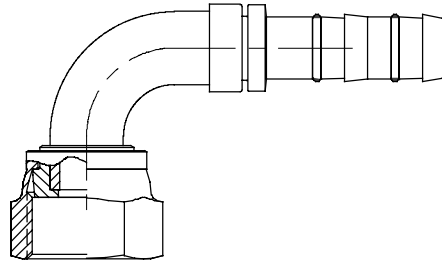

<b>Kit Part Number</b>	<b>Description</b>
40-64094-50	Fitting, 90°, #10 ORS, Female Swivel X #10 Hose, FlexCLIK
40-64094-51	Fitting, 90°, #6 ORS, Female Swivel X #6 Hose, FlexCLIK
40-64094-52	Fitting, 90°, #8 ORS, Female Swivel X #8 Hose, FlexCLIK
40-64094-53	Fitting, 90°, #12 ORS, Female Swivel X #12 Hose, FlexCLIK
40-64094-54	Fitting, 90°, #4 ORS, Female Swivel X #6 Hose, FlexCLIK
40-64094-55	Fitting, 90°, #10 ORS, Female Swivel X #12 Hose, FlexCLIK
40-64094-56	Fitting, 90°, #8 ORS, Female Swivel X #6 Hose, FlexCLIK
40-64094-57	Fitting, 90°, #10 ORS, Female Swivel X #16 Hose, FlexCLIK
40-64094-58	Fitting, 90°, #10 ORS, Female Swivel X #12 Hose, FlexCLIK

**FITTING, 40-64095, SPLICER, WITH HIGH-SIDE ACCESS**

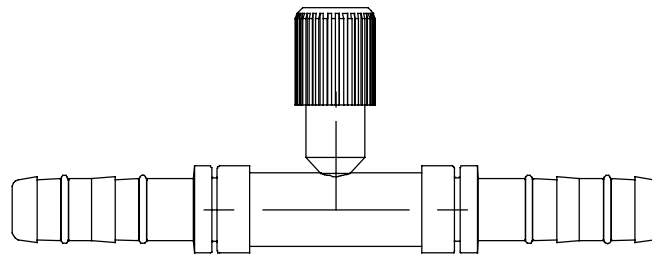

<b>Kit Part Number</b>	<b>Description</b>
40-64095-50	Fitting, Splicer, #10 Hose, FlexCLIK, With High Side R134a Port
40-64095-51	Fitting, Splicer, #6 Hose, FlexCLIK, With High Side R134a Port
40-64095-52	Fitting, Splicer, #8 Hose, FlexCLIK, With High Side R134a Port



**FITTING, 40-64106, 45 DEGREE FEMALE O-RING**

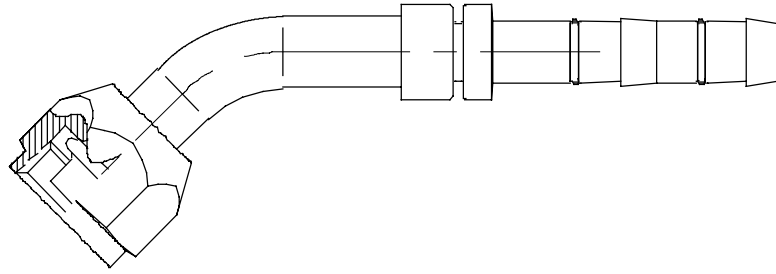

<b>Kit Part Number</b>	<b>Description</b>
40-64106-50	Fitting, 45°, #12 FOR (Short Pilot) X #12 Hose, FlexCLIK
40-64106-51	Fitting, 45°, #6 FOR (Short Pilot) X #6 Hose, FlexCLIK
40-64106-52	Fitting, 45°, #6 FOR (Short Pilot) X #8 Hose, FlexCLIK
40-64106-53	Fitting, 45°, #8 FOR (Short Pilot) X #8 Hose, FlexCLIK
40-64106-54	Fitting, 45°, #8 FOR (Short Pilot) X #10 Hose, FlexCLIK
40-64106-55	Fitting, 45°, #10 FOR (Short Pilot) X #10 Hose, FlexCLIK
40-64106-56	Fitting, 45°, #10 FOR (Short Pilot) X #12 Hose, FlexCLIK
40-64106-57	Fitting, 45°, #12 FOR (Short Pilot) X #16 Hose, FlexCLIK
40-64106-58	Fitting, 45°, #10 FOR (Short Pilot) X #16 Hose, FlexCLIK

**FITTING, 40-64115, SPLICER, WITH LOW-SIDE ACCESS**

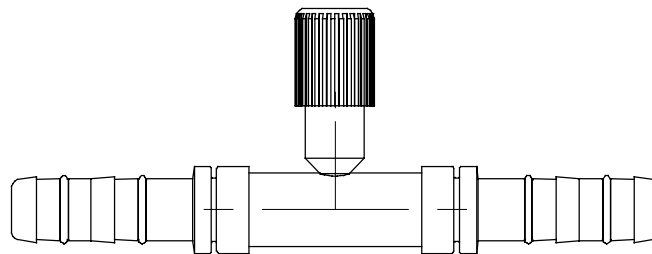

<b>Kit Part Number</b>	<b>Description</b>
40-64115-50	Fitting, Splicer, #10 Hose, FlexCLIK, With R134a Low Side Port
40-64115-51	Fitting, Splicer, #12 Hose, FlexCLIK, With R134a Low Side Port
40-64115-52	Fitting, Splicer, #16 Hose, FlexCLIK, With R134a Low Side Port



**SECTION 5**

**FlexCLIK HOSE - CLAMPS - CAGES & O-RINGS**

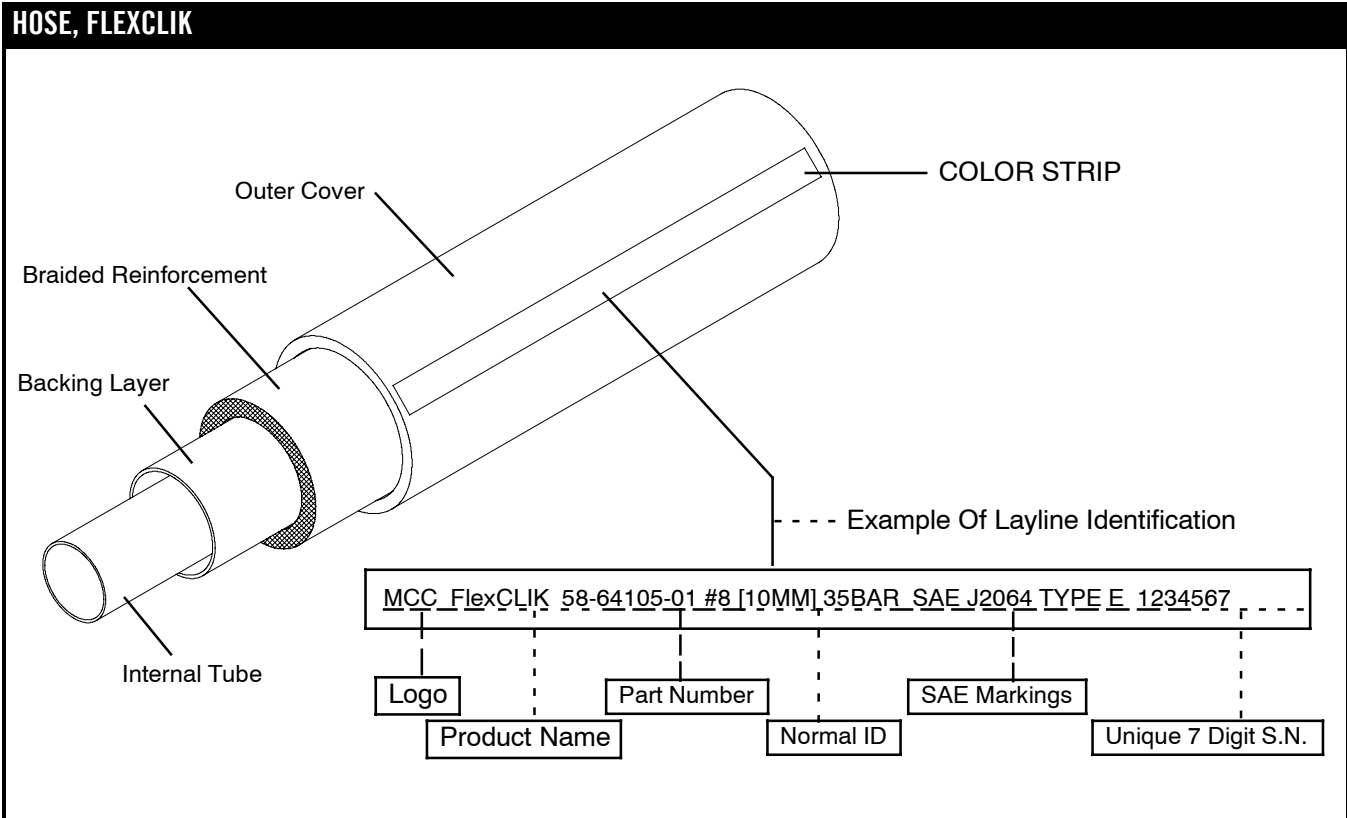

58-64105-90	FlexCLIK Hose, (Black) (5/16) #6 x 50 Foot (8.1 MM I.D X 15.2 MM O. D.)
58-64105-13	FlexCLIK Hose, (Green)(13/32) #8 x 50 Foot (10.7 MM I.D X 18.2 MM O. D.)
58-64105-24	FlexCLIK Hose, (Red) (1/2) #10 x 50 Foot (13.2 MM I.D X 20.3 MM O. D.)
58-64105-34	FlexCLIK Hose, (Blue) (5/8) #12 x 50 Foot (16.3 MM I.D X 25.1 MM O. D.)
58-64105-44	FlexCLIK Hose, (Blue) (7/8) #16 x 50 Foot (16.3 MM I.D X 25.1 MM O. D.)

**HOSE CLAMPS / CAGE KITS- FlexCLIK**

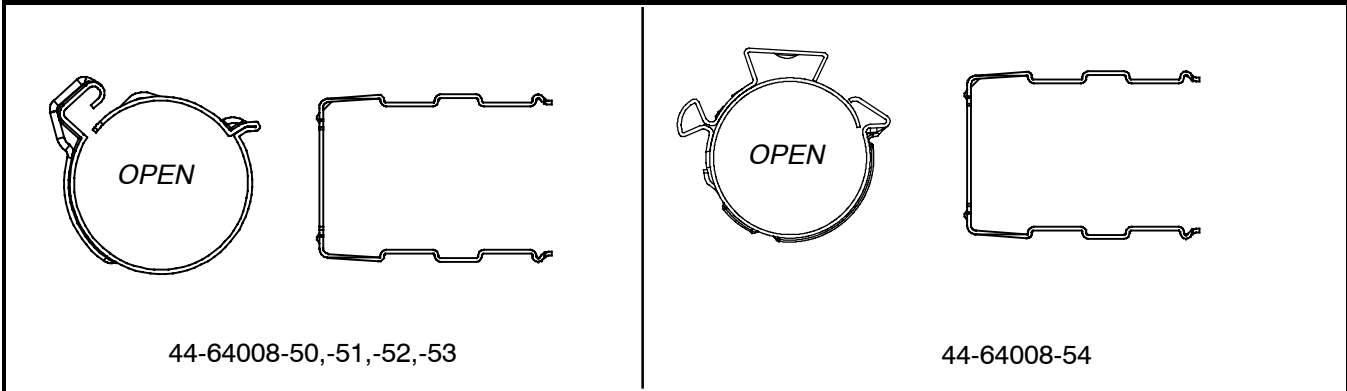

44-64008-50	Clamp/Cage Kit, #6, FlexCLIK,
44-64008-51	Clamp/Cage Kit, #8, FlexCLIK,
44-64008-52	Clamp/Cage Kit, #10, FlexCLIK,
44-64008-53	Clamp/Cage Kit, #12, FlexCLIK,
44-64008-54	Clamp/Cage Kit, #16, FlexCLIK,



**HOSE CLAMPS - FlexCLIK**

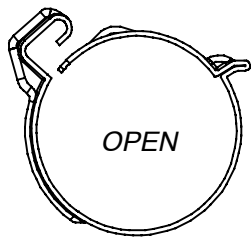

OPEN



CLOSED

44-64009-00,-01,-02, -03

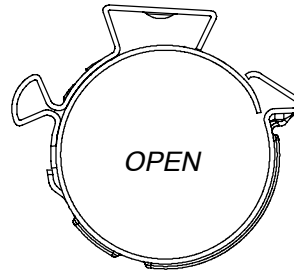

OPEN



CLOSED

44-64009-04

44-64009-00	Clamp, FlexCLIK, #6 (CLIC 86 N 150)
44-64009-01	Clamp, FlexCLIK, #8 (CLIC 86 N 175)
44-64009-02	Clamp, FlexCLIK, #10 (CLIC 86 N 200)
44-64009-03	Clamp, FlexCLIK, #12 (CLIC 86 N 245)
44-64009-04	Clamp, FlexCLIK, #16 (CLIC E N 285)

**CAGE, FlexCLIK**

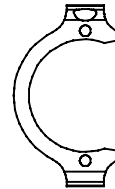
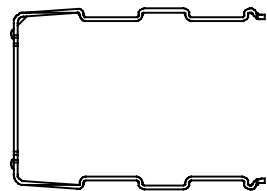

44-64008-00	Clamp, Cage, FlexCLIK, #6
44-64008-01	Clamp, Cage, FlexCLIK, #8
44-64008-02	Clamp, Cage, FlexCLIK, #10
44-64008-03	Clamp, Cage, FlexCLIK, #12
44-64008-04	Clamp, Cage, FlexCLIK, #16

**O-RING, FlexCLIK**

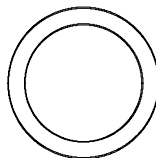

42-62157-00	O-Ring, FlexCLIK Nipple, Hose End, #4
42-62157-01	O-Ring, FlexCLIK Nipple, Hose End, #6
42-62157-02	O-Ring, FlexCLIK Nipple, Hose End, #8
42-62157-03	O-Ring, FlexCLIK Nipple, Hose End, #10
42-62157-04	O-Ring, FlexCLIK Nipple, Hose End, #12
42-62157-05	O-Ring, FlexCLIK Nipple, Hose End, #16



# INDEX

PART #	PAGE #	PART #	PAGE #
<b>0</b>			
07-00507-00	1, 2	40-60060-06	10
07-00467-00	2	40-60060-07	10
07-00508-00	2	40-60060-08	10
		40-60061-02	11
		40-60061-03	11
		40-60061-04	11
		40-60061-05	11
		40-60061-06	11
		40-60061-07	11
		40-60061-08	11
		40-60078-02	11
		40-60078-03	11
		40-60078-04	11
		40-60078-05	11
		40-60078-06	11
		40-60078-07	11
		40-60079-02	10
		40-60079-03	10
		40-60079-04	10
		40-60079-05	10
		40-60079-07	10
		40-60081-02	10
		40-60081-03	10
		40-60081-04	10
		40-60081-05	10
		40-60083-02	11
		40-60083-03	11
		40-60083-04	11
		40-60083-07	11
		40-60083-08	11
		40-60084-05	10
		40-60084-06	10
		40-60086-03	10
		40-60086-04	10
		40-60086-05	10
		40-60137-03	10
<b>4</b>			
40-60048-01	12		
40-60048-02	12		
40-60048-03	12		
40-60048-04	11		
40-60048-05	12		
40-60048-07	12		
40-60048-10	12		
40-60050-02	12		
40-60050-03	12		
40-60050-04	12		
40-60050-05	12		
40-60050-06	12		
40-60050-07	12		
40-60050-08	12		
40-60051-02	11		
40-60051-03	11		
40-60051-04	11		
40-60051-07	11		
40-60051-08	11		
40-60058-04	12		
40-60058-05	12		
40-60059-02	12		
40-60059-03	12		
40-60059-04	12		
40-60060-02	10		
40-60060-03	10		
40-60060-04	10		
40-60060-05	10		





# INDEX

<b>PART #</b>	<b>PAGE #</b>	<b>PART #</b>	<b>PAGE #</b>
40-60137-04	10	40-62131-50	10, 19
40-60137-05	10	40-62131-51	10, 19
40-62012-00	10	40-62131-52	10, 19
40-62012-01	10	40-62136-50	10, 19
40-62012-02	10	40-62136-51	10, 19
40-62022-00	10	40-64073-50	10, 20
40-62022-01	10	40-64073-51	10, 20
40-62023-00	10	40-64073-52	10, 20
40-62023-01	10	40-64073-53	10, 20
40-62088-00	10	40-64073-54	10, 20
40-62089-00	10	40-64073-55	10, 20
40-62101-50	10, 15	40-64074-50	10, 20
40-62101-51	10, 15	40-64074-51	10, 20
40-62101-55	10, 15	40-64074-52	10, 20
40-62102-50	10, 15	40-64074-53	10, 20
40-62102-51	10, 15	40-64074-54	10, 20
40-62102-52	10, 15	40-64074-55	10, 20
40-62103-50	10, 16	40-64074-56	10, 20
40-62103-51	10, 16	40-64074-57	10, 20
40-62112-50	10, 16	40-64074-58	10, 20
40-62112-51	10, 16	40-64074-59	10, 20
40-62112-52	10, 16	40-64074-60	10, 20
40-62112-53	10, 16	40-64075-50	11, 21
40-62112-54	10, 16	40-64075-51	11, 21
40-62127-50	17	40-64075-52	11, 21
40-62127-51	17	40-64075-53	11, 21
40-62127-52	17	40-64075-54	11, 21
40-62127-53	17	40-64075-55	11, 21
40-62127-54	17	40-64075-56	11, 21
40-62128-53	10, 18	40-64075-57	11, 21
40-62128-54	10, 18	40-64075-58	11, 21
40-62128-55	10, 18	40-64075-59	11, 21
40-62128-56	10, 18	40-64080-50	11, 22
40-62130-50	10, 18	40-64080-51	11, 22
40-62130-51	10, 18	40-64080-52	11, 22
		40-64080-53	11, 22



# INDEX

<b>PART #</b>	<b>PAGE #</b>	<b>PART #</b>	<b>PAGE #</b>
40-64080-56	11, 22	40-64094-54	12, 25
40-64080-57	11, 22	40-64094-55	12, 25
40-64080-58	11, 22	40-64094-56	12, 25
40-64080-59	11, 22	40-64094-57	12, 25
40-64081-5	22	40-64094-58	12, 25
40-64081-50	11, 22	40-64095-50	12, 25
40-64081-51	11, 22	40-64095-51	12, 25
40-64081-52	11, 22	40-64095-52	12, 25
40-64081-53	11, 22	40-64106-50	12, 26
40-64081-54	11, 22	40-64106-51	12, 26
40-64081-55	11	40-64106-52	12, 26
40-64081-56	11, 22	40-64106-53	12, 26
40-64081-57	11, 22	40-64106-54	12, 26
40-64082-50	11, 23	40-64106-55	12, 26
40-64082-51	11, 23	40-64106-56	12, 26
40-64082-52	11, 23	40-64106-57	12, 26
40-64084-5	11	40-64106-58	12, 26
40-64084-50	23	40-64115-50	12, 26
40-64084-51	11, 23	40-64115-51	12, 26
40-64084-52	11, 23	40-64115-52	12, 26
40-64084-53	11, 23	40-62128-52	18
40-64084-54	11, 23	42-62157-00	28
40-64084-55	11, 23	42-62157-01	28
40-64084-56	11, 23	42-62157-02	28
40-64089-50	11, 24	42-62157-03	28
40-64089-51	11, 24	42-62157-04	28
40-64089-52	11, 24	42-62157-05	28
40-64089-53	11, 24	44-64008-00	28
40-64089-54	11, 24	44-64008-01	28
40-64092-50	11, 24	44-64008-02	28
40-64092-51	11, 24	44-64008-03	28
40-64094-50	11, 25	44-64008-50	27
40-64094-51	12, 25	44-64008-51	27
40-64094-52	12, 25	44-64008-52	27
40-64094-53	12, 25	44-64008-53	27
		44-64008-54	27



# INDEX

<b>PART #</b>	<b>PAGE #</b>
44-64009-00	28
44-64009-01	28
44-64009-02	28
44-64009-03	28

## **5**

58-64105-13	27
58-64105-24	27

<b>PART #</b>	<b>PAGE #</b>
58-64105-34	27
58-64105-44	27
58-64105-90	27

## **A**

AC101-708	2
AC101-711	2

# Every driver deserves the best possible vehicle climate with MCC products

MCC provides exceptional performance in mobile climate comfort.



[www.mcc-hvac.com](http://www.mcc-hvac.com)

Member of MCC Group • Certified ISO 9001 and ISO 14001.  
Specifications subject to change without notice. MCC is a registered trademark.